

PRODUCT SPECS

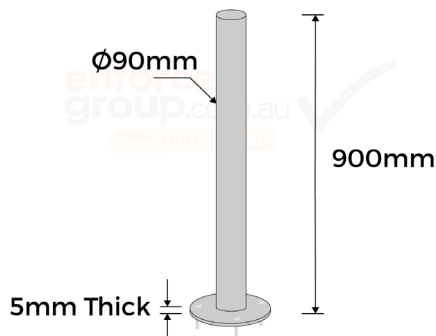
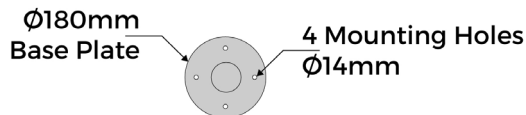

Product Code: B130 SM SS304-900

Diameter: 130mm

Height: 900mm

Weight: 11kg

Wall Thickness: 3mm

Base Plate: 250mm diameter
x 5mm thick, 4
mounting holes
14mm diameter

Finish: Silver Brushed Stainless Steel



2 Year
Manufacturing
Warranty

Installation
Service
available

BOLLARD 130MM SURFACE MOUNTED STAINLESS STEEL 304

- Manufactured from heavy duty Steel Pipe
- Silver Brushed grade 304 Stainless Steel
- Withstands from heavy cars, trucks, and forklifts
- Designed in Australia for Australian Conditions
- Strong Metal Bollard machined-flat top
- Installation Service is available

Enforcer Steel Bollards are designed in Australia for Australian Conditions, Environmentally friendly Manufactured from Steel Pipe, and 100% Recyclable.

Silver grade 304 Stainless Steel, with architectural brushed Stainless-Steel finish, fully welded round base plate.

Easy to install or relocate, designed to be strong and durable, with a welded strong metal Bollard machined-flat top cap.

Suited to use in Concrete to withstand from cars, trucks, and forklifts. for all Shopping centres, Warehouses, Car Parks, Driveways, even Machinery, together with architectural standards.



Strong &
Durable



Australian
Standards
Approved



Easy
Installation

enforcer
group.com.au

Call us 1300 85 40 10